

AGNESE SBROLLINI

Consortium  
**GARR**

THE ITALIAN  
EDUCATION  
& RESEARCH  
NETWORK



# **ATHLETE: Sistema in-Cloud per il Monitoraggio Cardiovascolare dello Sportivo**

GIORNATA DI INCONTRO  
BORSE DI STUDIO GARR  
"ORIO CARLINI"  
ROMA

Roma

Borsisti Day 2019



# Cos'è la Morte Cardiaca Improvvisa da Sport?

«**Morte** naturale dovuta a **cause cardiache**, preceduta dalla rapida perdita di coscienza, entro un'ora dall'insorgere della sintomatologia acuta, in soggetti con o senza cardiopatia nota preesistente, ma per i quali **tempi e modalità del decesso sono inaspettati**»



**DURANTE ATTIVITA'  
FISICA**



# Screening dello sportivo: cosa guardare?

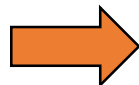

Elettrocardiogramma (ECG)

Fonocardiogramma (PCG)

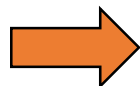
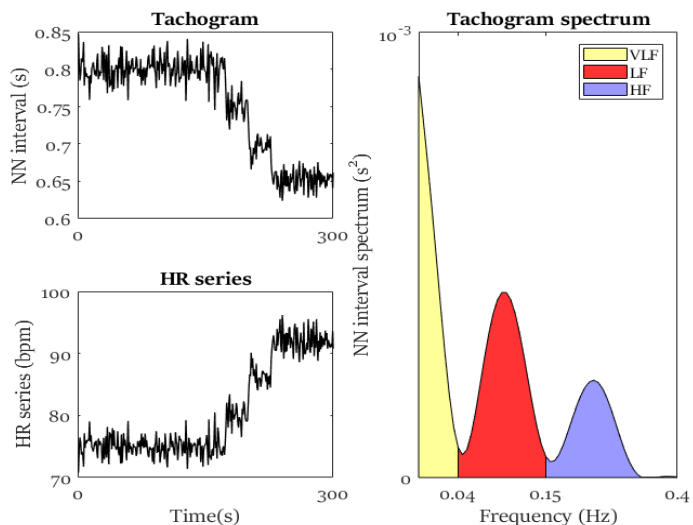
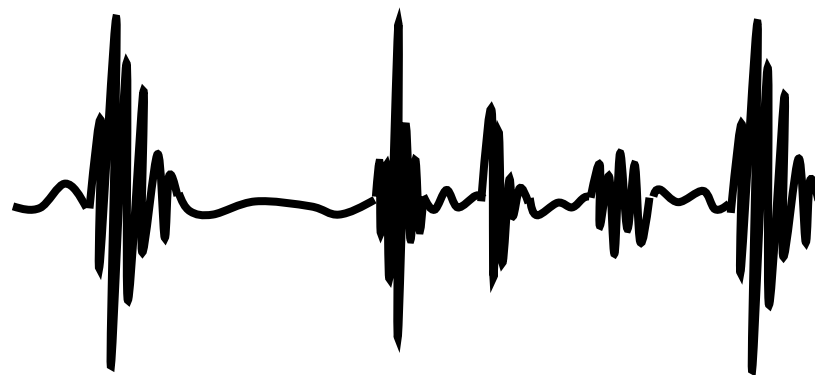
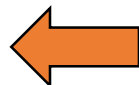

Tacogramma

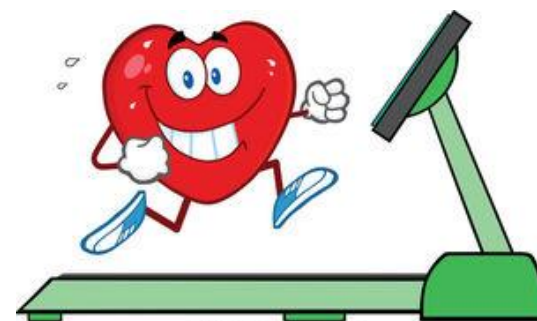



# Come misurare questi segnali?





# Cosa posso fare?

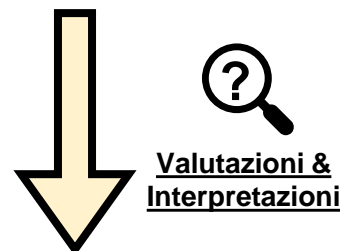
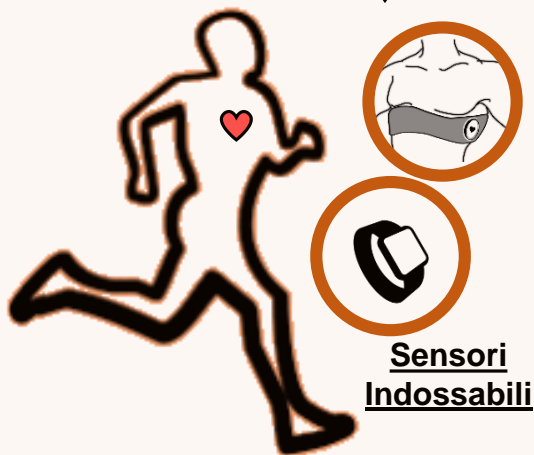
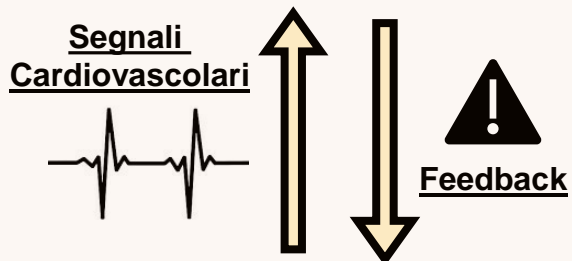
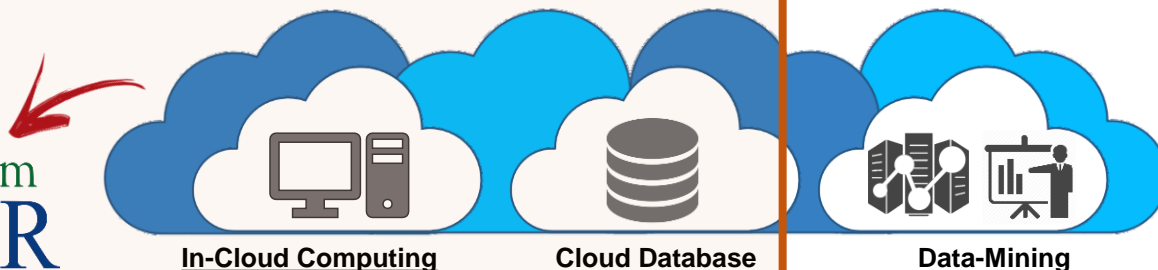





# Cosa posso fare?



Sensori  
Indossabili



Centri di Ricerca





# Il mio GANTT

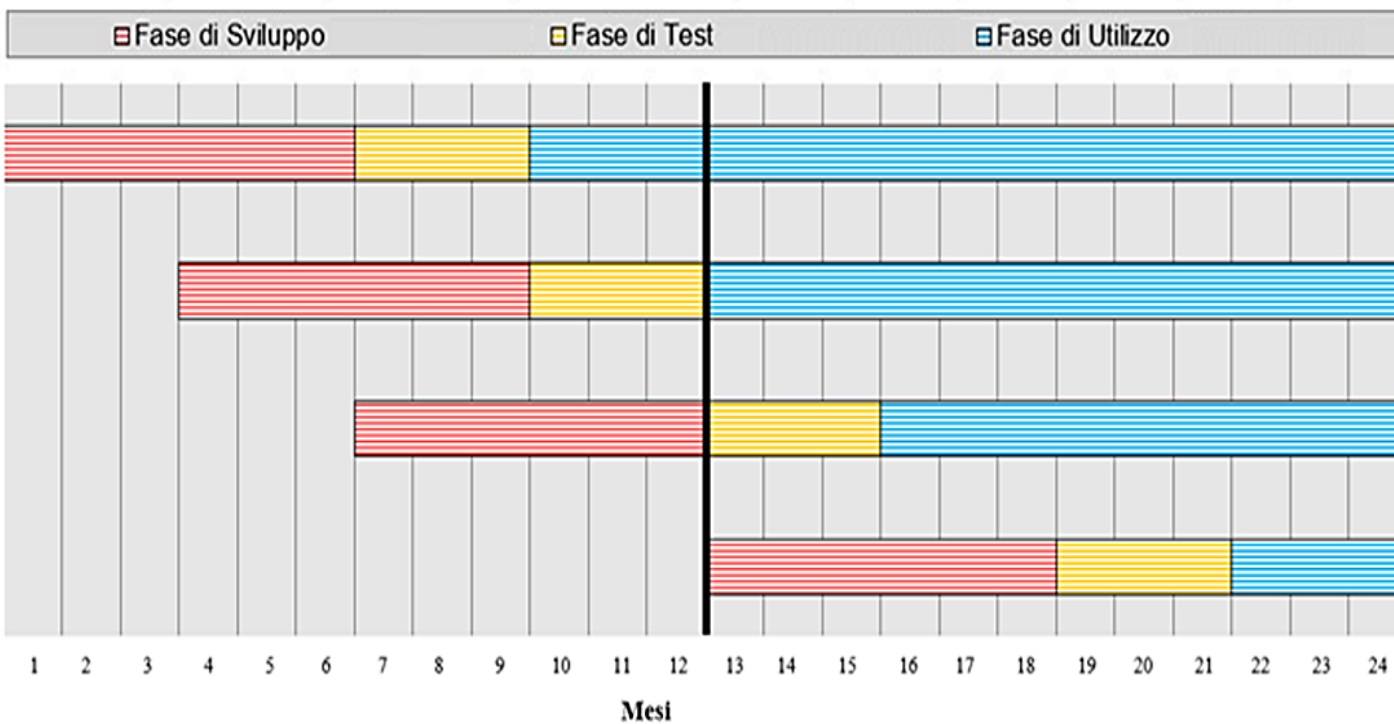

Applicazione per la raccolta e il trasferimento dati

Applicazione Cloud-native per lo storage dei dati

Applicazioni in-Cloud computing per il singolo atleta

Applicazioni data-mining per la ricerca scientifica





# Acquisizione Dati



ECG



TACOGRAMMA



- D. Nepi, A. Agostinelli, E. Maranesi, **A. Sbrollini**, M. Morettini, F. Di Nardo, S. Fioretti, L. Burattini (2016) On the Clinical Use of the Heart-Rate Signal Provided by the Zephyr BioHarness 3.0 8th International Workshop on Biosignal Interpretation BSI 2016, Osaka Novembre 2016.
- D. Nepi, **A. Sbrollini**, A. Agostinelli, E. Maranesi, M. Morettini, F. Di Nardo, S. Fioretti, P. Pierleoni, L. Pernini, S. Valenti, L. Burattini (2016) Validation of the Heart-Rate Signal Provided by the Zephyr BioHarness 3.0 Computing in Cardiology, Vancouver, Settembre 2016.





# Acquisizione Dati



**~ 100**  
**acquisizioni**



# Acquisizione Dati

MEZZOFONDO

CORSA

TENNIS

ZUMBA

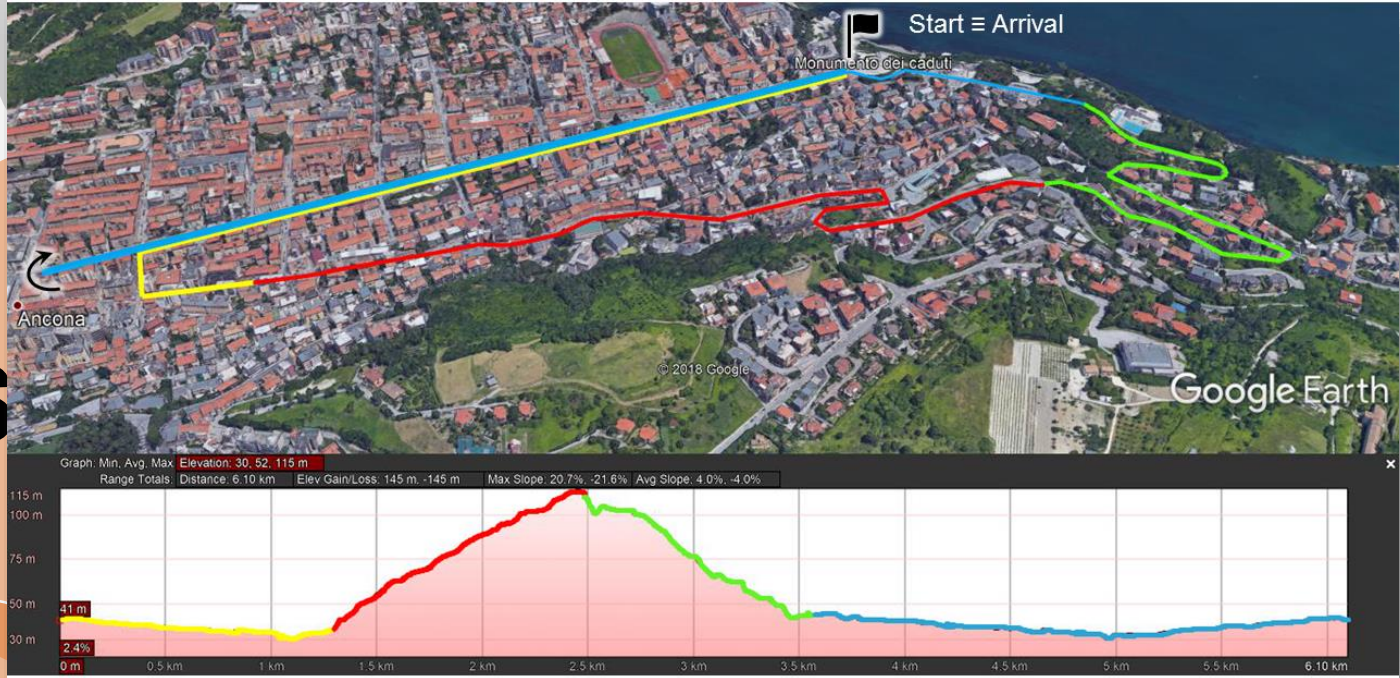



# Automonitoraggio: CaRiSMA

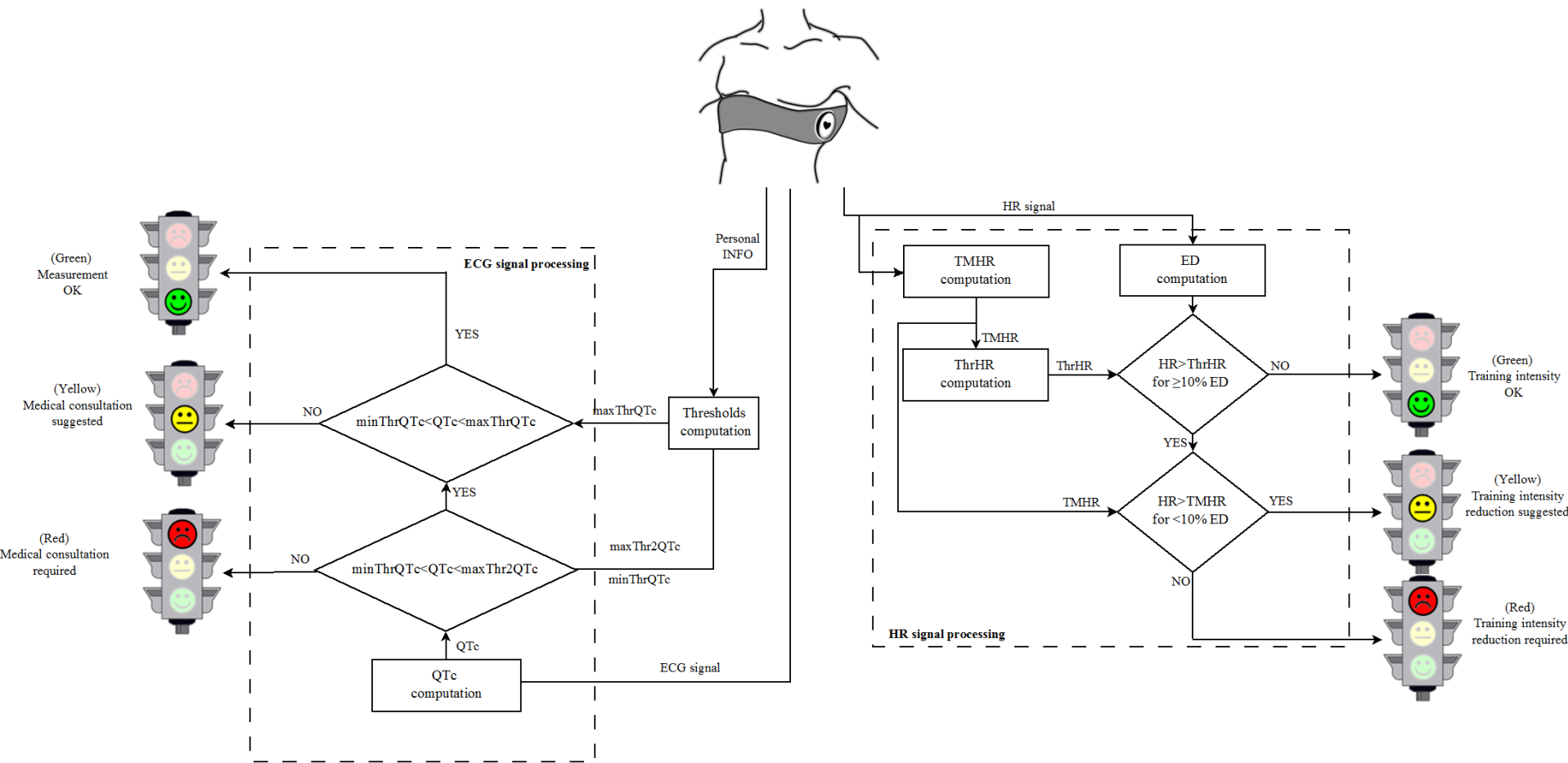

A. Agostinelli, M. Morettini, **A. Sbrollini**, E. Maranesi, L. Migliorelli, F. Di Nardo, S. Fioretti, L. Burattini (2017) CaRiSMA 1.0: Cardiac Risk Self-Monitoring Assessment The Open Sports Sciences Journal, 10, 179-190





# Automonitoraggio: CaRiSMA

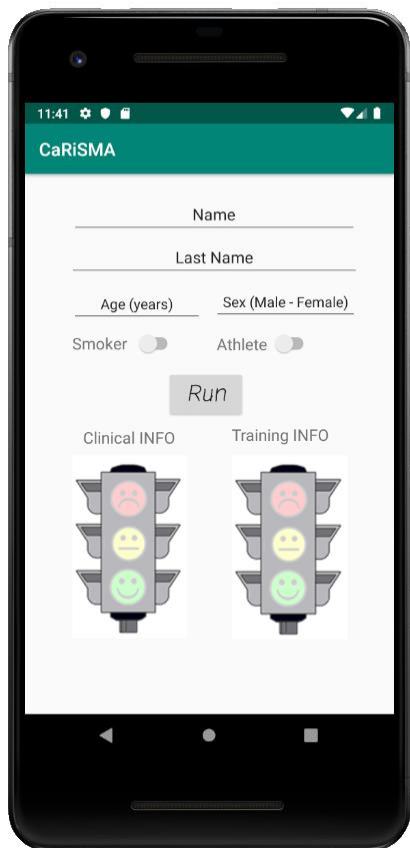

	R1	R2	R3	R4	R5	R6	R7	R8	R9	R10	
<b>TMHR (bpm)</b>	193	192	193	188	193	188	193	190	193	187	
<b>thrHR (bpm)</b>	164	163	164	160	164	160	164	162	164	159	
<b>HR (bpm)</b>	<i>I</i>	169±9	168±17	160±9	163±28	165±17	177±12	176±12	164±11	169±26	171±8
	<i>U</i>	179±3	189±4	184±5	187±4	190±5	196±3	186±2	177±6	194±6	180±8
	<i>D</i>	168±5	178±7	173±9	183±4	183±8	185±6	186±2	172±5	182±6	175±9
	<i>F</i>	174±3	181±3	181±4	188±4	186±4	193±1	173±21	178±4	187±4	182±33
<b>HRS-TL</b>											
<b>minThrQT (ms)</b>	321	321	321	321	321	321	321	321	321	321	
<b>maxThr1QT (ms)</b>	479	469	469	469	469	469	469	469	469	469	
<b>maxThr2QT (ms)</b>	499	499	499	499	499	499	499	499	499	499	
<b>QT (ms)</b>	401	373	423	385	423	414	417	432	447	483	
<b>QT-TL</b>											

Around Ancona sembra essere faticoso!!!





# ATHLETE DB: un database ad Hoc

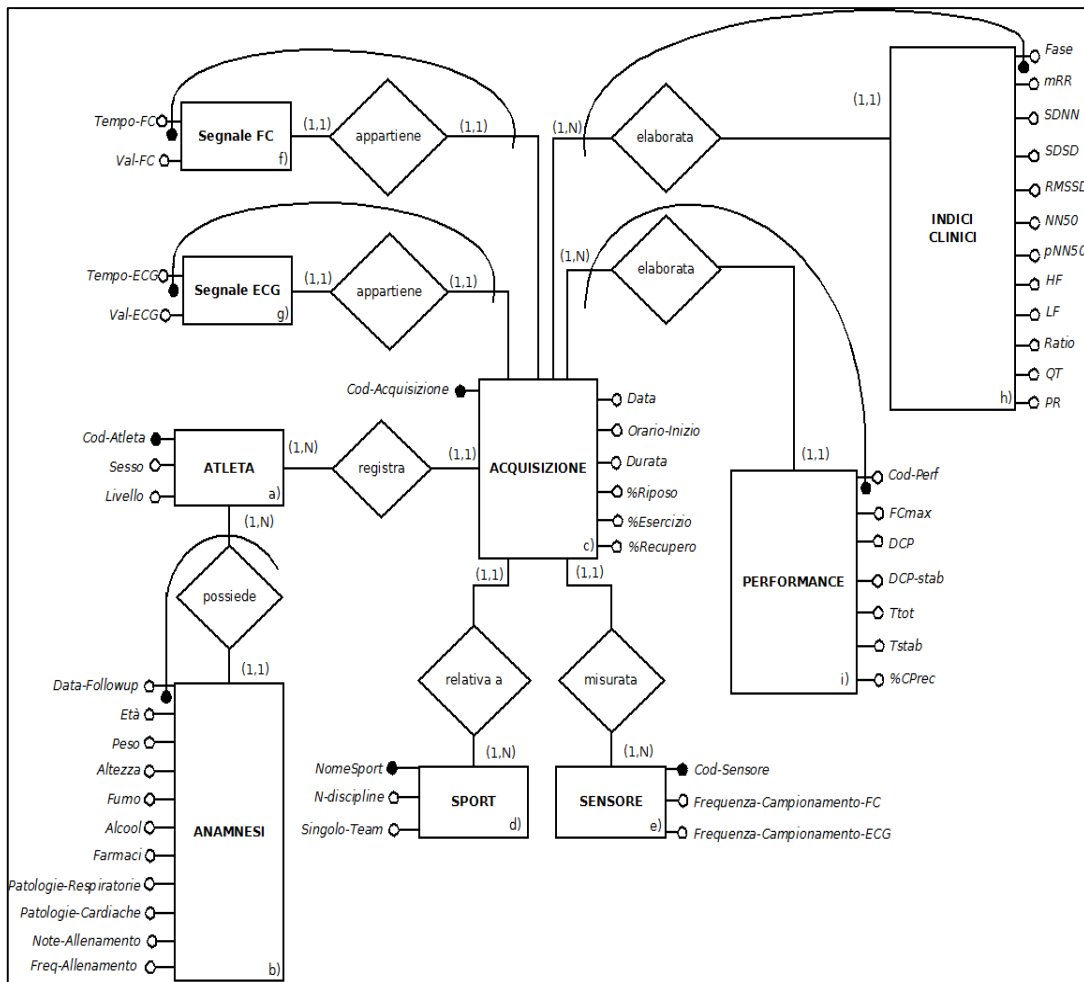





# ATHLETE DB: un database ad Hoc

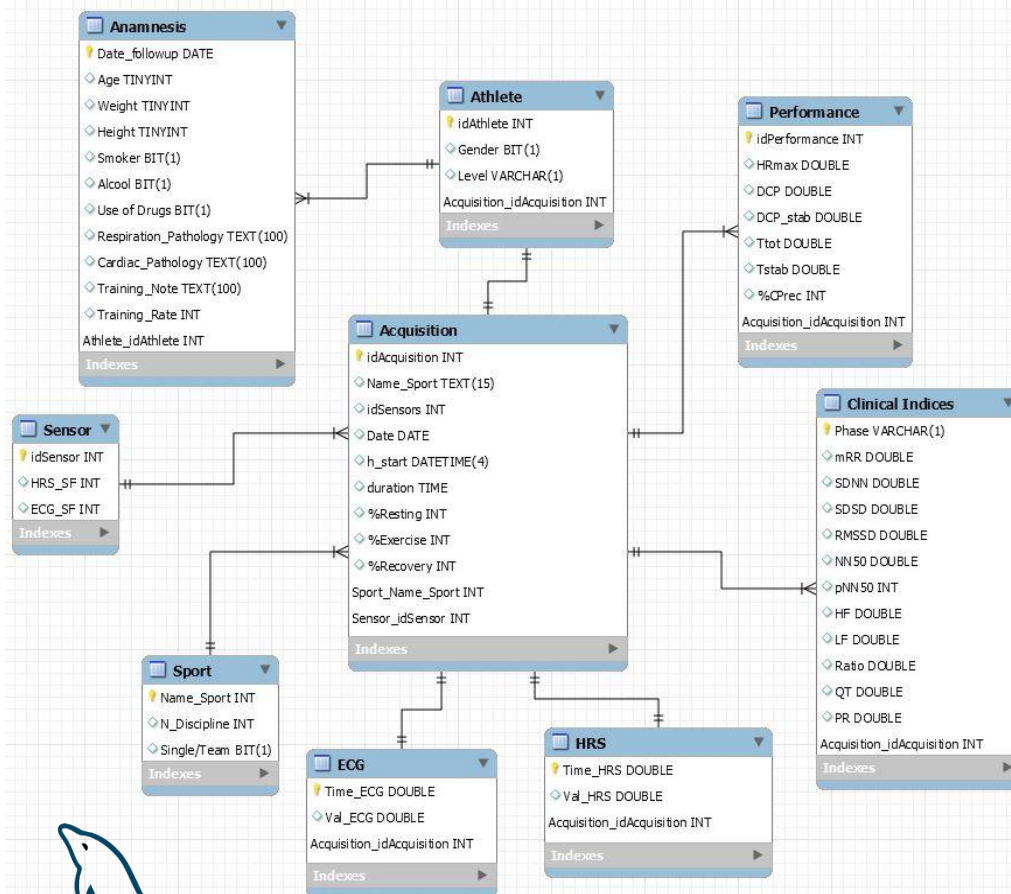



# ATHLETE DB: un database ad Hoc

ATHLETE è stato creato per:

- **Atleti e Allenatori**
- **Bioingegneri e Ricercatori**
- **Medici**

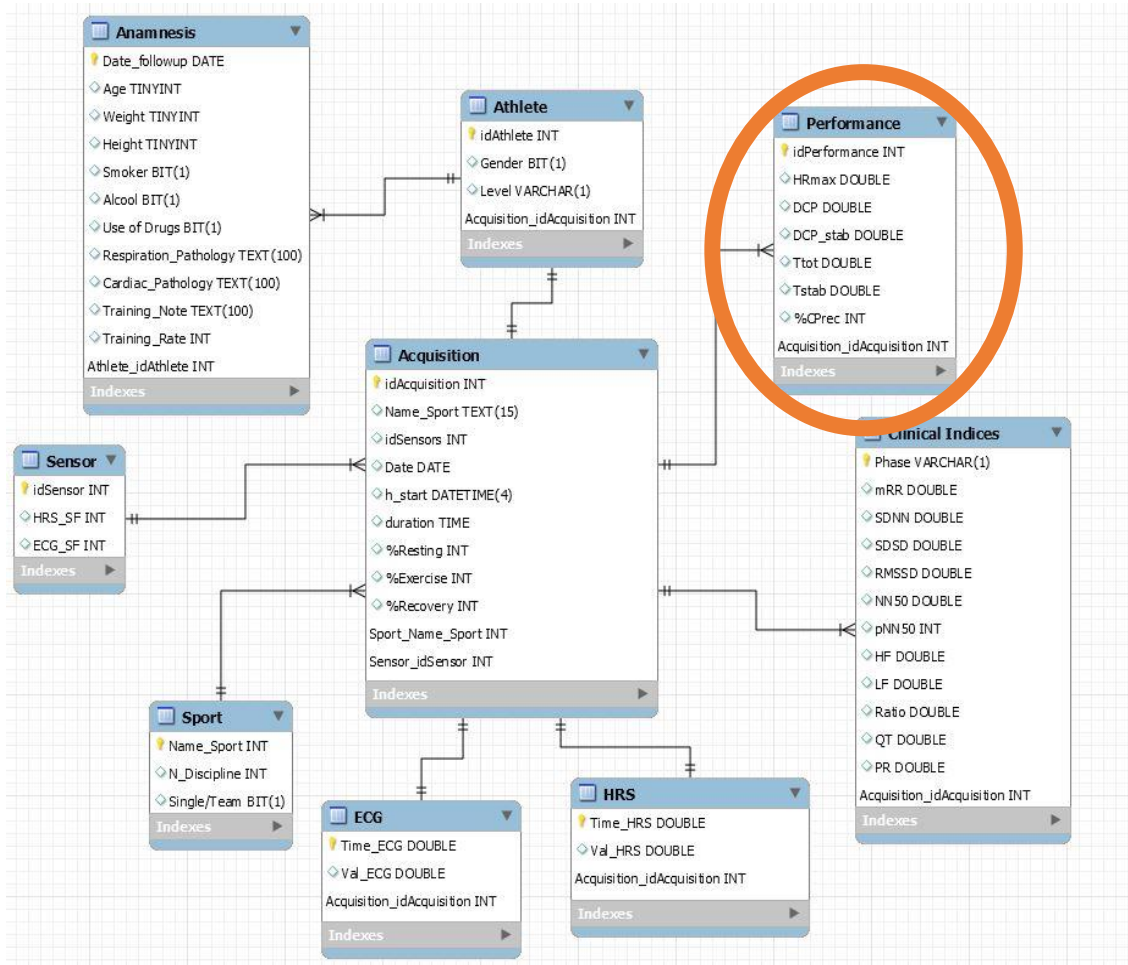



# ATHLETE DB: un database ad Hoc

ATHLETE è stato creato per:

- Atleti e Allenatori
- **Bioingegneri e Ricercatori**
- Medici

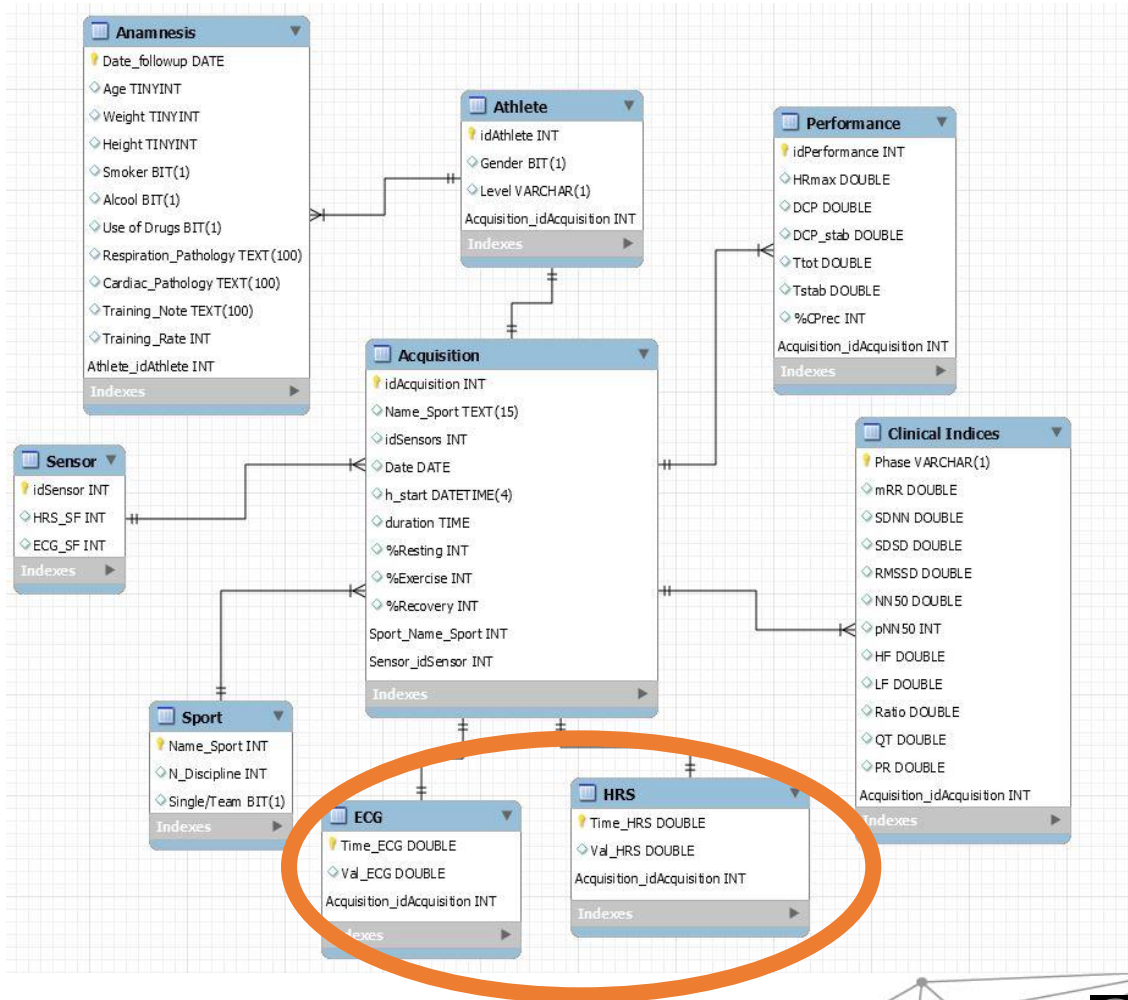





# ATHLETE DB: un database ad Hoc

ATHLETE è stato creato per:

- Atleti e Allenatori
- Bioingegneri e Ricercatori
- **Medici**

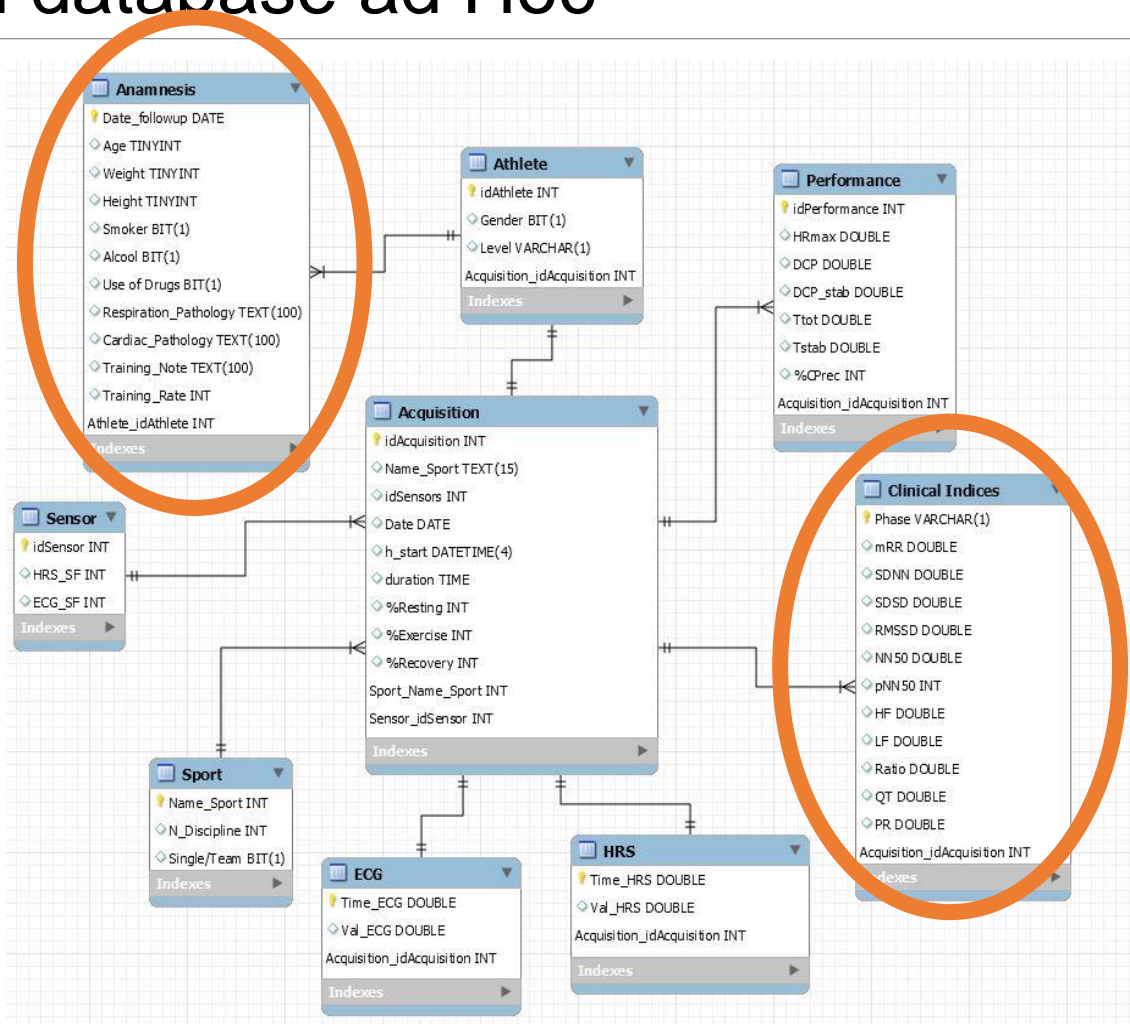



# ATHLETE APP

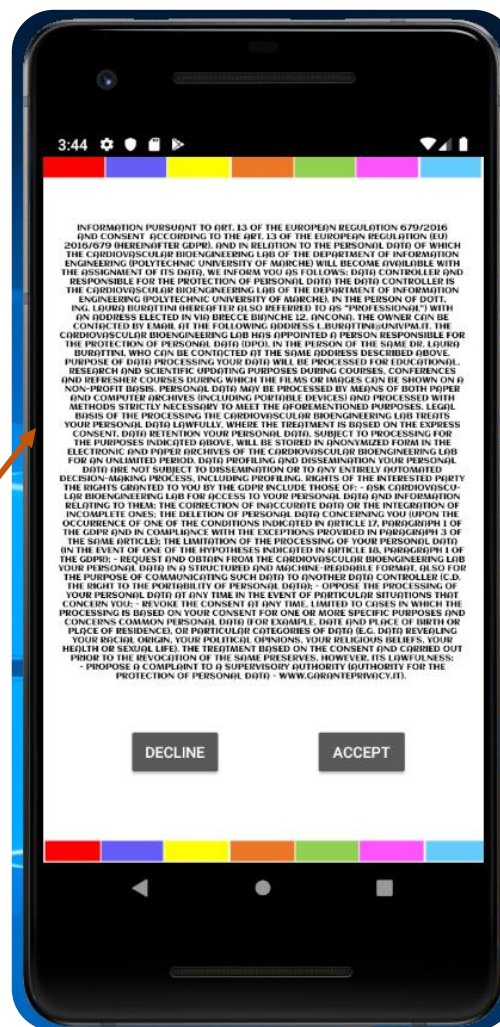
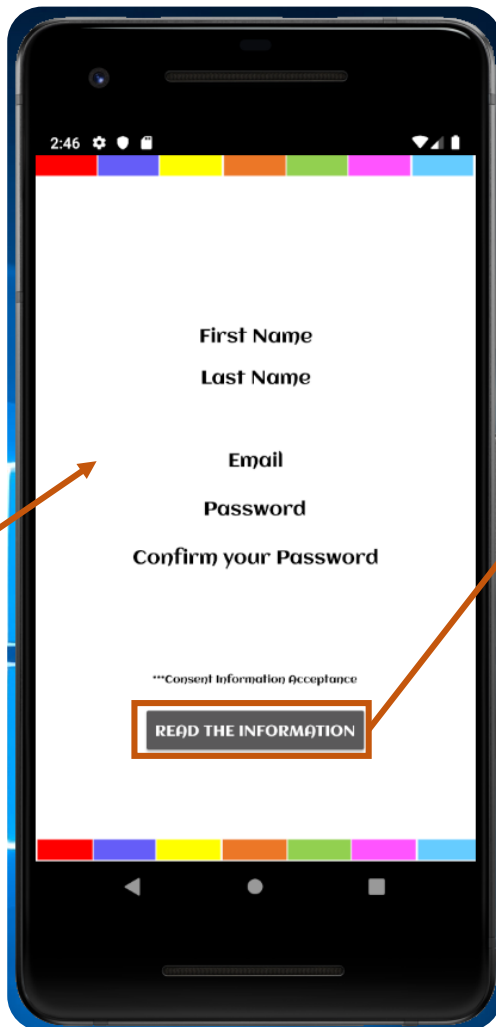





# ATHLETE APP





# ATHLETE in Cloud

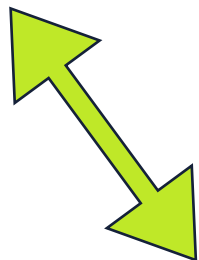

GARR  
cloud



# ATHLETE vola a Tallin... con Luca & Enrico







Nel Futuro....



**FEEDBACK  
AL MEDICO**

**TELECONSULTING**

**DATA MINING PER IL  
SUPPORTO ALLA  
DIAGNOSI**

**INTEGRAZIONE DI  
ALTRI SEGNALI  
BIOMEDICI**



With the heart...

Let's make them Champions!!!